

REV.	DESCRIPTION	DATE
1	INITIAL DESIGN	04-11-09
2	REVISED TO ADD TOUCH SCREEN	04-11-09
3	REVISED TO ADD OSD CONTROL	04-11-09
4	REVISED TO ADD HMI	04-11-09
5	REVISED TO ADD AC POWER IN	04-11-09
6	REVISED TO ADD HDMI, DVI, VGA	04-11-09
7	REVISED TO ADD HMI CONNECTOR	04-11-09
8	REVISED TO ADD HMI CONNECTOR	04-11-09

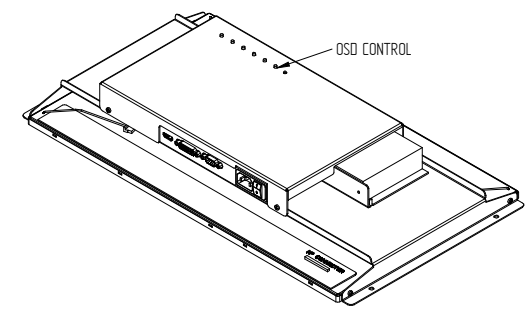
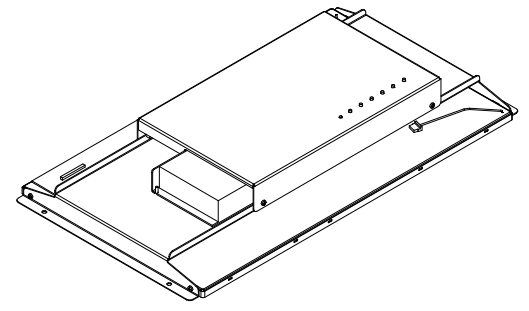
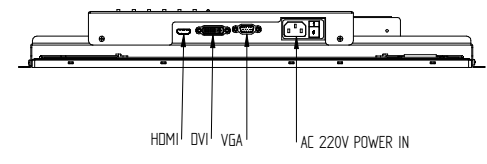
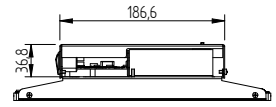
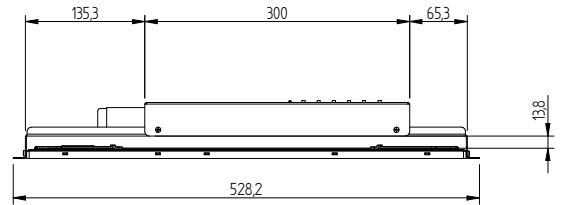
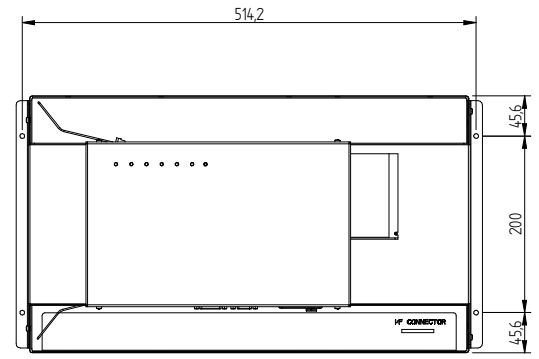
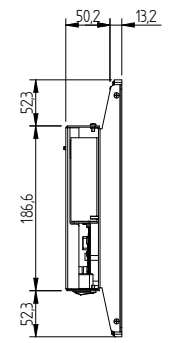
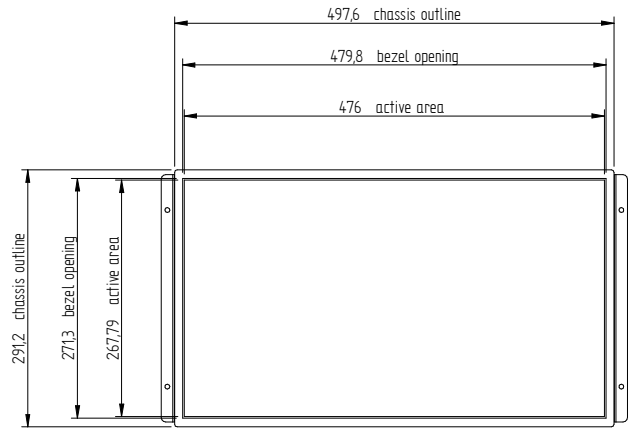

Model Name	Model Code	Revision Number	Rev. No.	Scale
CA15	8			
© 2009 SAMSUNG ELECTRONICS CO., LTD. ALL RIGHTS RESERVED. SAMSUNG ELECTRONICS CO., LTD. IS NOT RESPONSIBLE FOR ANY DAMAGE TO PERSONS OR PROPERTY CAUSED BY THE USE OF THIS PRODUCT.				
Samsung reserves all rights in this document and its contents.				
Document Name	Document Code	Document No.	Document Rev.	Document Date
Open Frame 21.5" FHD 1500r/c No Touch				04-11-09
Author	Checker	Appr.	Rev. No.	Rev. Date
			1.0	04-11-09
OPEN FRAME 21.5" FHD 1500r/c NO TOUCH				
OP215JML500V1				